

# SP New

R290, R452a ed R449



**Attention: risk of fire – R290**

OPERATOR'S MANUAL

ENGLISH

PAGE 2

100%  
MADE  
IN ITALY



Manufacturer of this appliance is

**S.P.M. Drink Systems S.p.A. – Via Panaro 2/b 41057 Spilamberto (MO)**

All reproduction rights of this manual are reserved to it, even partial reproduction is prohibited.

The descriptions and illustrations refer to the specific machine/plant in question. The manufacturer reserves the right to make any modifications he deems appropriate to series production at any time.

This manual:

- it is an integral part of the supply and must be read carefully in order to use it correctly, in compliance with the essential safety requirements;

- it is drawn up according to the provisions of the Machinery Directive 2006/42/EC and contains the technical information necessary to correctly carry out all the procedures in safe conditions;

- it must be stored with care (protected in a transparent and watertight casing to prevent deterioration) and must accompany the machine throughout its life, including any change of ownership. In the event of loss or deterioration, a copy can be obtained by requesting the manufacturer, reporting the data on the identification plate

The manufacturer declines all responsibility for improper use of the machine/plant and/or for damage caused as a result of operations not covered in this manual.

## INDEX

1. SAFETY INSTRUCTIONS.....	4
Cleaning and daily sanitizing procedures .....	5
2. EQUIPMENT KIT .....	11
3. TRANSPORT TIPS .....	11
4. LIFTING TIPS.....	11
5. TECHNICAL SPECIFICATIONS .....	12
6. POSITIONING .....	13
7. CONNECTION TO THE POWER SUPPLY MAINS.....	14
8. CONTROL PANEL (FIG.21).....	15
9. THERMOSTAT CONTROLLER .....	16
Operation mode.....	16
10. OPERATING INSTRUCTIONS AND START-UP PROCEDURES .....	17
11. SPECIAL MAINTENTANCE.....	19
Condenser cleaning .....	19
Control and replacement of seals .....	20
Winter storage .....	20
Product storage.....	20
12. DISCLAIMER .....	20
13. TROUBLESHOOTING GUIDE .....	21
14. WIRING DIAGRAM.....	22

## 1. SAFETY INSTRUCTIONS

**This** installation and operation manual is an integral part of the equipment and must be kept for future consultation.

**U**nless otherwise stated, this manual is addressed to operators (staff members who uses the equipment on a daily basis) and to servicemen (staff members qualified to carry out the installation and/or

maintenance). **T**he parts of the manual addressed only to servicemen are pointed out accordingly. **P**lease read carefully the warnings listed here below before installation and start-up of the equipment.

**T**his equipment has been designed to produce coffee cream, ice cappuccino, sorbets, slushes and similar frozen dairy products obtained by blending water or milk with the powder.

**U**pon receipt of the equipment, make sure that its part number matches the one specified in the order, which can be found on all the delivery documents.

**T**his equipment is exclusively destined to the purpose for which it was designed.

**T**he manufacturer cannot be held responsible for any damage due to improper use.

**T**his appliance can be used by children aged from 8 years and above and persons with reduced physical, sensory or mental capabilities or lack of experience and knowledge if they have been given supervision or instruction concerning use of the appliance in a safe way and

understand the hazards involved. **C**hildren shall not play with the appliance. **C**leaning and user maintenance shall not be made by children without supervision.

**T**his equipment is not suitable for outdoor use. This machine is not suitable for installation in locations where water jets

are used and it must not be cleaned by a water jet.

**T**his appliance is intended for professional use and must be installed in places where it can be checked by qualified personnel.

**D**o not store explosive substances such as aerosol cans with a flammable propellant in this appliance.

**T**his appliance is intended to be used in household and similar applications such as – staff kitchen areas in shops, offices and other working environments;  
– farm houses and by clients in hotels, motels and other residential type environments;  
– bed and breakfast type environments;  
– catering and similar non-retail applications.

**T**he installation and subsequent servicing operations must be carried out by skilled members who have been trained to use the device and in compliance with the regulations in force.

**T**he machine has to be placed on a sturdy, horizontal surface making sure it is well ventilated by leaving a gap of 20 cm around it and do not install it near heat sources (fig.1); we recommend you to maintain a room temperature between 24 and 32°C (between 75°F and 90°F).

**F**or a safe and correct installation, it is essential to provide a suitable socket controlled by a thermal cut-out switch whose contacts are at least 3 mm apart, in accordance with the current national safety regulations.

**I**f the power cable is damaged, it must be replaced by the manufacturer, its after sale service or by qualified personnel, to prevent any possible risk.

- **WARNING:** do not locate multiple portable socket-outlets or portable power supplies at the rear of the appliance.

- **WARNING:** when positioning the appliance, ensure the supply cord is not trapped or damaged.

- **WARNING:** Keep ventilation openings, in the appliance enclosure or in the built-in structure, clear of obstruction (IEC 60335-2-24)

- **WARNING:** Do not use mechanical devices or other means to accelerate the defrosting process, other than those recommended by the manufacturer (IEC 60335-2-24)

- **WARNING:** Do not damage the refrigerant circuit (IEC 60335-2-24)

The continuous, equivalent, weighted level of acoustic pressure is below 70 dB.

**This manual is also available in an alternative format on our website.**

### ***Cleaning and daily sanitizing procedures***

In order to maintain the unit in like-new operating condition and to respect current regulations, it's absolutely necessary to frequently and carefully perform the cleaning and sanitizing operations as described below.

In case of prolonged shutdown (winter storage), the machine must be disassembled, washed and sanitized according to the instructions in this manual before start-up to ensure the best possible cleanliness.

## **!Caution!**

**E**lectric shock hazard. Do not splash water on switches or allow water to flow onto electrical components inside the machine.

## **!Caution!**

**T**o prevent bacteria growth, use only sanitizers approved for plastic and rubber objects, failure to do so could create a health hazard.

**Note:** it is responsibility of the operator to be aware of and conform to the requirements of current local, state and federal laws concerning the frequency of cleaning and conservation of products used.

The cleaning instructions explained in this section are essential procedures to remove bacteria and maintain a sanitarily clean machine.

***We recommend to perform the cleaning and sanitizing procedures every day and anyway according to the local laws.***

The machine and the mix manufacturers decline all responsibility to damage that directly or indirectly derives from people, animals, as consequence of failure to comply with all cleaning and sanitation instructions indicated in this manual.

- **S**top the freezing system and let the machine run with the only auger activated (position O for the small button, position I for the main one) for ten minutes.

- **P**rovide yourself with a sanitizer suitable for plastic, rubber and stainless steel objects

(**S**odium hypochlorite 2%), for the US market bring the approved KAY-5® Sanitizer/Cleaner with a 100ppm dilution (1 Oz packet of KAY-5® +2 ½ gallons of water) (the sanitizing product shall comply with 40 CFR §180.940).

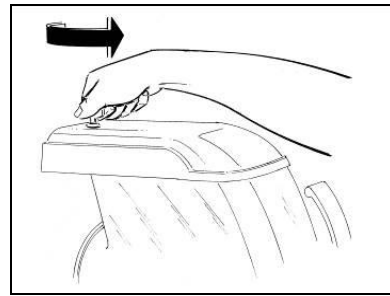

Fig. 1

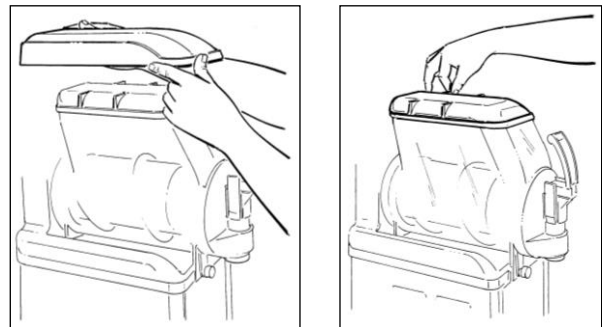

Fig. 2

- **A**fter unlocking the main cover with its key (fig.1), remove the main cover and the secondary one under it (fig.2).

- **P**our lukewarm water into the bowl (fig.3) and, after re-positioning the main cover, make the scraper auger rotating for some minutes.

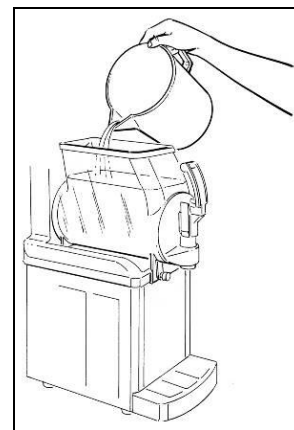

Fig. 3

## NOTE

**S**P is equipped with a very efficient safety mechanism, activated when the cover is lifted, designed to protect the operator. **If the cover is not correctly positioned SP will not work.**

- **E**mpy the bowl and repeat the same operations until the coming out water is clear (fig.4).

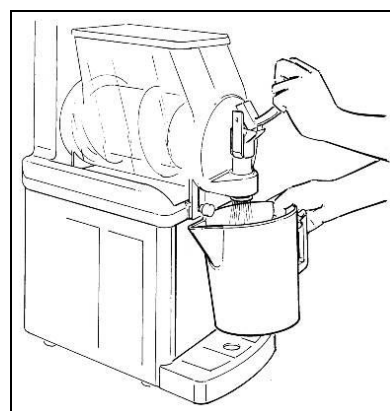

Fig. 4

## Caution

**To avoid electrical shock or contact with moving parts, before proceeding with the disassembling operations, make sure all switches are in "OFF" position and that the main power supply is disconnected.**

- **S**witch off the machine and disconnect the power cable.
- **R**emove the main cover.
- **W**ash and sanitize your hands and forearms.
- **U**nscrew the bowl knobs (fig.5).

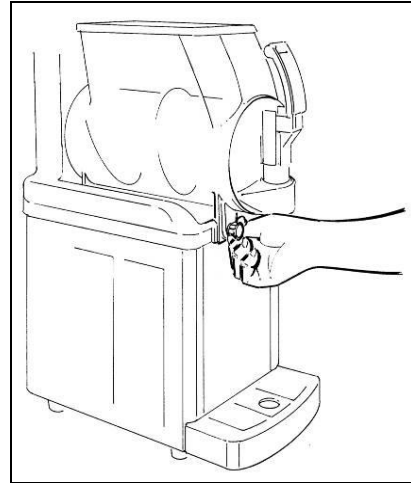

Fig. 5

- **S**imultaneously press the two securing tabs and lift the tap to extract it from its seat (see fig.6).
- **D**isassemble the tap by keeping the body pressed down and slipping the lever from its seat (fig.6).

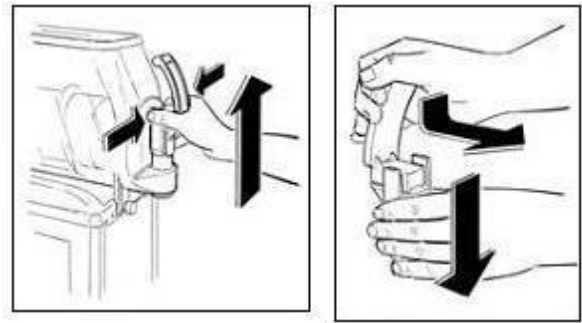

Fig. 6

## Caution

**To prevent bacteria growth, remove all o-rings when cleaning.**

**Failure to do so could create a health hazard.**

- **P**ull the bowl outward, as shown, to completely remove it from its seat (fig.7).

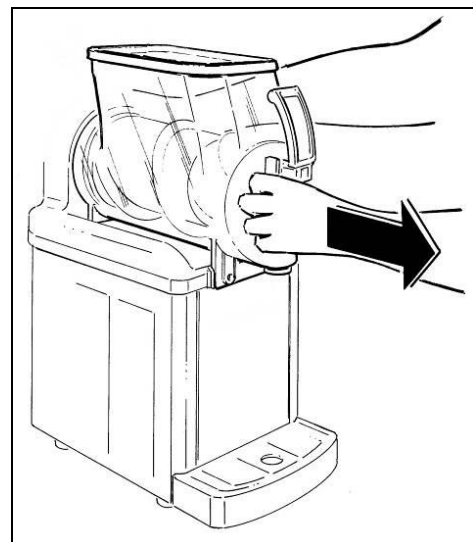
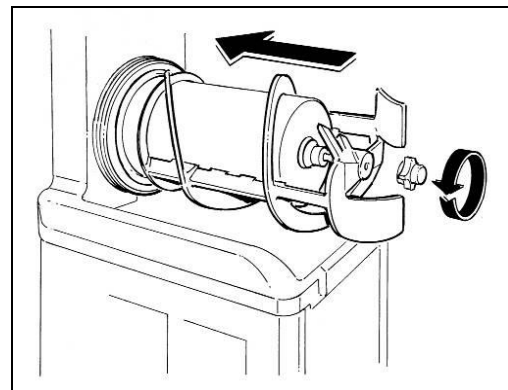

Fig. 7

- **U**nscrew the security knob in the direction of the arrow (threading on left), then pull out the mixing unit, the bell shaped seal and the bowl gasket on the back (fig.8).

- **R**emove the drip tray pulling it outward (fig.9).

- **T**horoughly wash all the removed components with hot water and dish washing, but do not use abrasive detergents or powders that can damage the bowl.



**Fig. 8**

## **IMPORTANT**

**Do not use too aggressive sanitizers or detergents, these kind of products could damage the bowl and the other components.**

## **CAUTION**

**Never perform these washing operation with a dish washing machine; failure to do so could seriously damage the unit's parts.**

- **R**inse well and then place all the components in the sanitizer solution; for proper sanitizing the parts must remain fully plunged as recommended by the sanitizer manufacturer (KAY-5 sanitizer suggest at least 1-2 minutes).

- **A**fter respecting the correct sanitizing period, rinse well all the components with clean water and dry them up with a clean cloth.

- **T**horoughly wash the evaporator and the drip tray surfaces with a sponge soaked with the sanitizer (see fig.10).

- **R**epeat all these operations with a clean sponge soaked with water and carefully dry up all the surfaces with a clean cloth.

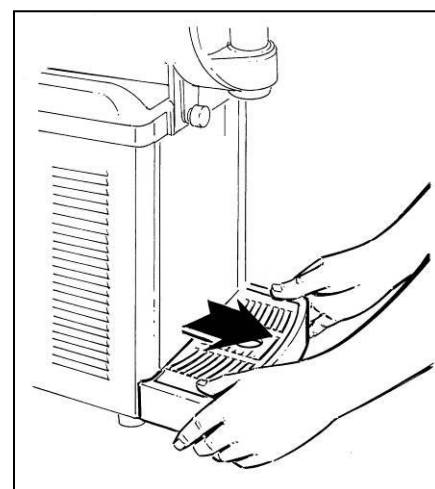

**Fig. 9**

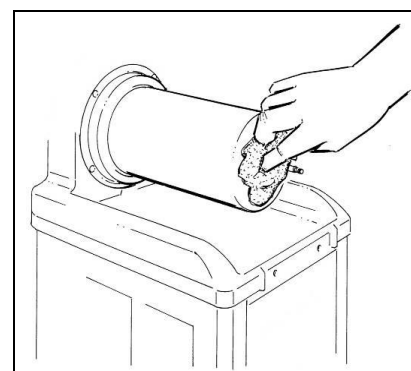

**Fig. 10**



Once performed all these cleaning and sanitizing procedures, it's possible to reassemble all the components.

*The correct assembly of the device is essential to prevent leakage of product and damage of the machine. To assemble the machine you will need an approved lubricant (such as Vaseline). Make sure all parts have been washed and sanitized before assembling. Persons assembling the machine must first wash and sanitize their hands and forearms with an approved sanitizer.*

- Spread Vaseline on the bell shaped seal internal surface before reassembling it (fig.11).



Fig. 11

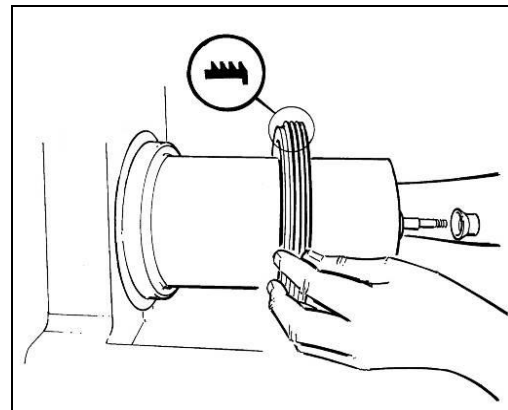

Fig. 12

- Reassemble the rear gasket and the bell shaped one, respecting the correct direction as indicated in figure 12.

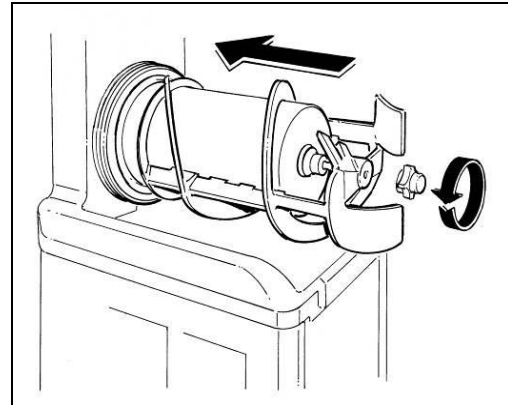
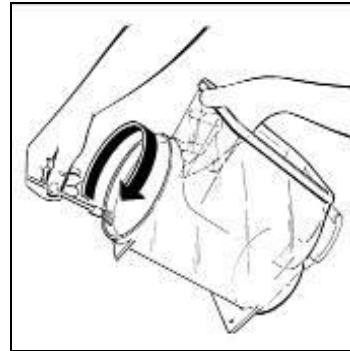

Fig. 13

- Reassemble the mixing unit making sure that the frontal cylinder perfectly fit inside its rotating shaft seat.

- Block all these components into place by turning the knob in counter clockwise direction (fig.13).

- **L**ubricate the rear of the tank where it meets with the seal to facilitate the reassembling procedures (see fig.14);



**Fig. 14**

- **R**eassemble the bowl by positioning it back into its seat, verifying that it faces in the correct direction and it is held in place by its seal (see fig.15).

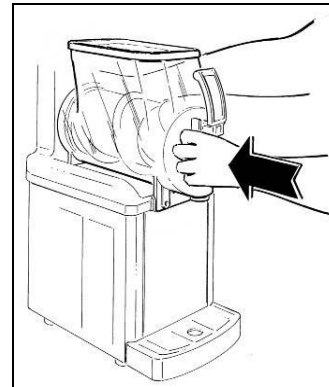

**Fig. 15**

- **F**ix the bowl by reinsert the knobs (fig.16).

## **IMPORTANT**

**D**o not over tighten the bowl knobs.

**E**xcessive force could damage the thread and/or the bowl itself.

- **R**e-insert the tap (fig.17) spreading Vaseline on the o-rings to facilitate sliding the tap in its seat until completely inserted.

## **!Warning!**

**I**f the tap does not perfectly slide into position, the sealing hold will be endangered.

- **R**eassemble the drip tray.

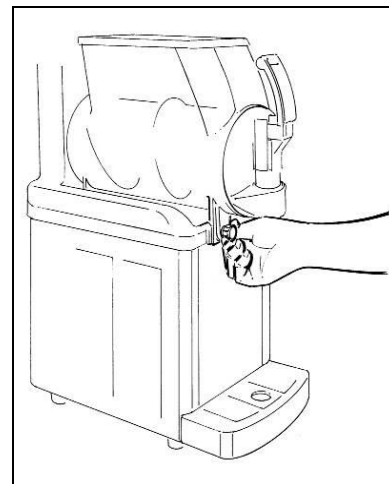

**Fig. 16**

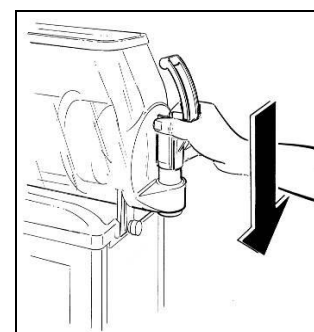

**Fig. 17**

## Sanitizing

Whenever the machine has remained unused for some days after been cleaned and sanitized as described in the chapter 9, the sanitizing procedures described below must be performed just prior to start-up the machine.

- **R**emove the main cover and the secondary one.
- **P**our sanitizing solution into the bowl carefully following the manufacturer prescriptions.
- **A**fter restoring the main cover, switch on the machine and let the auger rotating (all control board LED switched off) leaving the sanitizing solution for the time specified by its producer.

### IMPORTANT

**Never let the sanitizer inside the bowl for more than 15 minutes.**

- **D**rain the solution by opening the plunger to allow the bowl to empty. Open and close the plunger at least 10 times during draining to sanitize the product way out area also.
- **T**horoughly rinse repeating these operations with clean water instead of sanitizer solution.
- **N**ow the machine is ready to be used.

## 2. EQUIPMENT KIT

In the packaging of this equipment you will find also:

- operator's manual.
- 1 tube of Vaseline grease lubricant to be used for machine maintenance.
- EC declaration of conformity.
- 1 drip tray.

## 3. TRANSPORT TIPS

To prevent the oil held in the hermetic compressor running into the cooling circuit, the device must be carried, stored and handled in the upright position, following the direction instructions on the packing. If the device is accidentally or intentionally (for transportation reasons) kept in any other position, it must be set again in the correct position at least twenty minutes before start-up procedures, in order to let the oil flow back into the compressor.

## 4. LIFTING TIPS

Each machine is equipped with a special wooden pallet that allows the handling with standard forklift trucks.



Never lift the machine alone, but always seek the assistance of another operator.

To prevent and avoid any damage to the machine, all loading and unloading operations should be carried out with special care. The equipment can be lifted, with either a manual or engine-powered lifting truck, by positioning the forks in the base section of the unit.

**The following operations should always be avoided:**

- to turn upside down the machine;
- to drag the machine with ropes or others;
- to lift the machine with slings or ropes
- to shake or rattle the machine and its packaging.

The machine must be stored in a dry place with temperatures from 0°C to 40 °C. No more than 2 machines should be stacked on top of each

other, taking care to maintain the vertical position, as shown by the arrows on the carton.

## 5. TECHNICAL SPECIFICATIONS

### Technical and electrical specifications

All the machine's technical and electrical specifications are stated on the identification plate, positioned in the internal part of the equipment; a sample is shown here below.

The plate specifies:

- Model
- PNC – production code
- Serial number
- Electrical characteristics in Volt/Hz
- Max absorption in Watts
- Max current in Amps
- Climatic class
- Refrigerant gas and quantity used
- Markings
- Manufacturer

### Noise emissions

The continuous, equivalent, weighted level of acoustic pressure is below 70 dB.

### Climatic class

Class N, indicates an ambient temperature for machine use between 24 and 32°C (between 75°F and 90°F).

### Dimensions:

The overall dimensions of the appliance are:

#### **SP1**

- Height: 61,2 cm.
- Width: 26,2 cm.
- Depth: 42,7 cm.
- Weight: 28 kg.

#### **SP2**

- Height: 61,2 cm.
- Width: 44,7 cm.
- Depth: 43,8 cm.
- Weight: 48 kg.

### Refrigerant

Between the gas used (R452a, R449 and R290) the R290 is potentially flammable and explosive.



Every possible precaution must be taken to avoid any danger connected with the nature of this gas during any ordinary and/or extraordinary operation carried out on the equipment.

### In the event of breakdown:

In most cases, any technical problem can be settled with slight interventions (please see the troubleshooting guide at the end of this manual); we therefore recommend you to carefully read this handbook before contacting the manufacturer or service centre.

### Disposal



All the parts of the packaging must be kept beyond the range of children, as they might represent a potential safety/health risk.

### **Important**

In respect of the environment, please dispose the packaging as illustrated.



This symbol:  means that the machine cannot be disposed as common waste. It must be handled in compliance with the provisions of European directive 2003/108/CE (Waste Electrical and Electronic Devices - WEEE) and the resulting national legislation, in order to prevent any potential damage to the environment and to create health risks. In order to correctly dispose of the device, please contact the distributor from which you purchased it or our after-sales service.

## 6. POSITIONING

### FOR MAINTENANCE WORKER ONLY

**The installation and subsequent servicing operations must be carried out by skilled members who have been trained to use the device and in compliance with the regulations in force.**

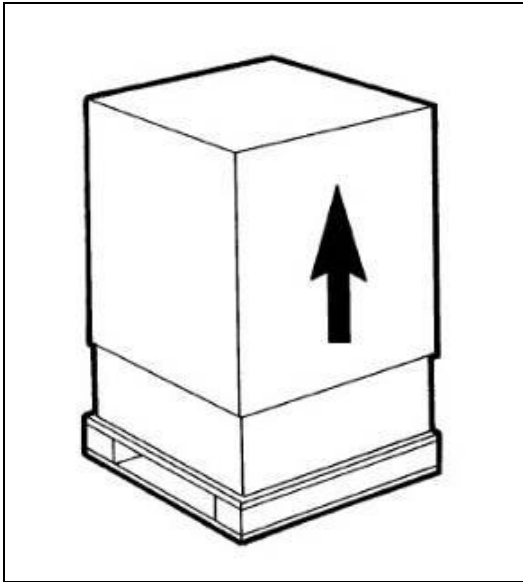

Fig. 18

- a) Remove the packing (fig.18) and preserve it in order to reuse for winter storage.

**⚠ Caution ⚠**

All the parts of the packaging must be kept beyond the range of children, as they might represent a potential safety/health risk.

- b) Make sure the machine is in perfect condition.

- c) Rest the machine on a sturdy, horizontal surface making sure it is well ventilated by leaving a gap of 20 cm around it and do not install it near heat sources (fig.19); **we recommend you to maintain a room temperature between 24 and 32°C (between 75 and 90°F).**

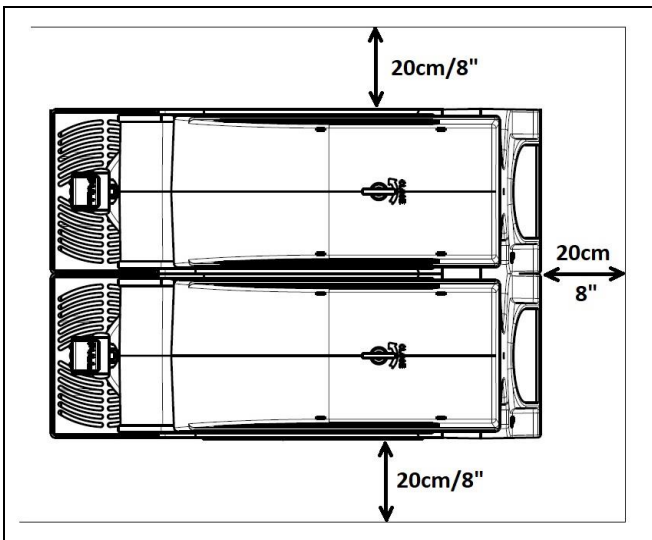

Fig. 19

- d) Check that the power mains voltage meets the specifications on the equipment identification plate and that the output available meets the device's power requirements. Fit the plug into an earthed socket, removing all multiple adaptors.

**FOR FURTHER PRECAUTIONS, READ THE SECTION "CONNECTION TO THE ELECTRICITY MAINS" CAREFULLY.**

- e) The installation must be carried out in accordance with the manufacturer's instructions. Failure to comply with the positioning and installation instructions may impair the machine's operation.

### **Important**

You are legally required to provide a suitable grounding system for the equipment. Before carrying out any cleaning and/or special maintenance on the device, make sure it is disconnected from the mains by unplugging it. In the event of a breakdown or malfunctioning, switch off the device and remove the plug.

## 7. CONNECTION TO THE POWER SUPPLY MAINS

### FOR SERVICEMAN ONLY

Before fitting the plug in the power supply socket, for your own safety, as already mentioned in the previous paragraph, please read the following precautions.

- The machine's electrical safety is only guaranteed when it is connected to a suitable earth system, structured as provided by the national safety current regulations (fig.20). Therefore, the manufacturer cannot be held responsible for any damage due to failure of the grounding system of the machine.

- Always verify electrical specifications on the data plate of each machine. Data plate specifications always replace the information of this manual.

- For a safe and correct installation, it is essential to provide a suitable socket controlled by a thermal cut-out switch whose contacts are at least 3 mm apart, in accordance with the current national safety regulations (see fig.20).

- **WARNING:** Do not locate multiple portable socket-outlets or portable power supplies at the rear of the appliance.

- **WARNING:** When positioning the appliance, endure the supply cord is not trapped or damaged.

- To unplug the device, first disconnect the power supply with the switch, then grip the plug and gently pull it out.

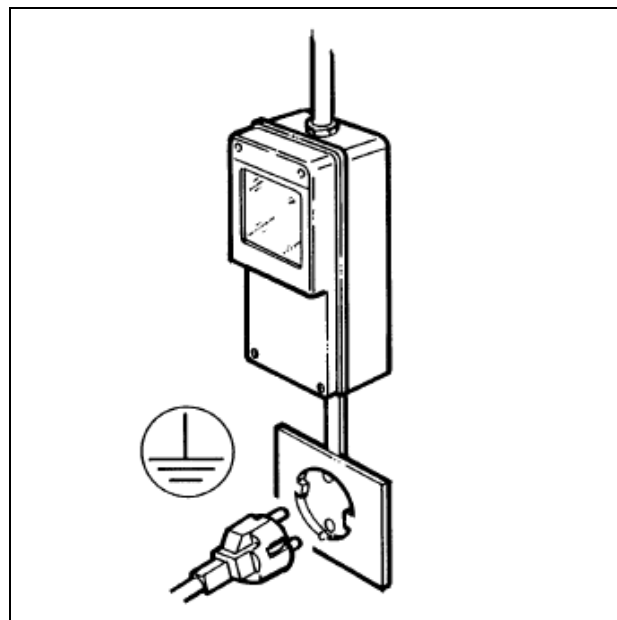

Fig. 20

**- If required by local regulations, it is possible to have the appliance permanently connected to electrical power supply, ref. National Electrical Code (NEC) and NFPA 70. If this is the case, it is necessary to remove the right side panel, disconnect the power cable from the machine wiring, remove it from the machine and replace it with the permanent cable by respecting the local codes.**

### **Important**

IF THE POWER CABLE IS DAMAGED, IT MUST BE REPLACED BY THE MANUFACTURER, ITS AFTER SALE SERVICE OR BY QUALIFIED PERSONNEL, TO PREVENT ANY POSSIBLE RISK.

## 8. CONTROL PANEL (FIG.21)

A: main switch

E (SP2 only): mixing spiral rotation activation switch (E1 left spiral, E2 right spiral)

B: refrigerator system management switch (B1 left side, B2 right side)



**Snowflake**: freeze hybrid mode

**Q**: washing



**Drops**: night mode (defrost)

C (LIGHT version only): light switch (C1 left side, C2 right side)

D (ULTRA version only): light switch (D1 left side, D2 right side)

**Position I**: Normal light mode, sanitization mode not active

**Position 0**: lights off

**Position II**: ULTRA sanitization mode, near UVA LED and normal LED in operation

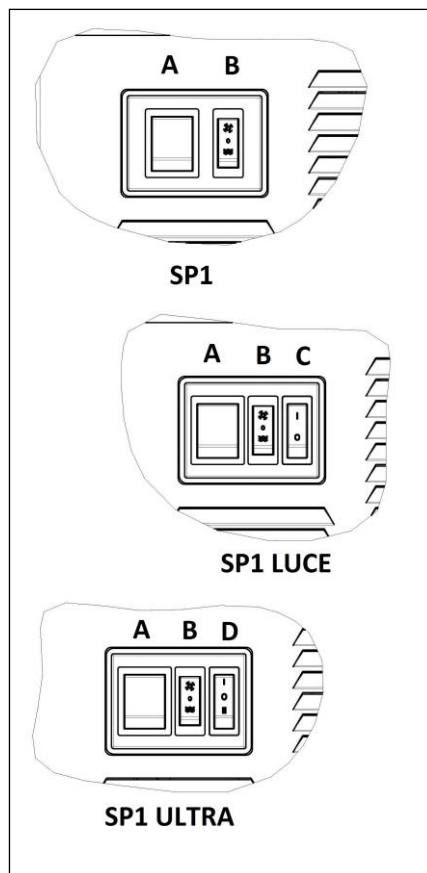
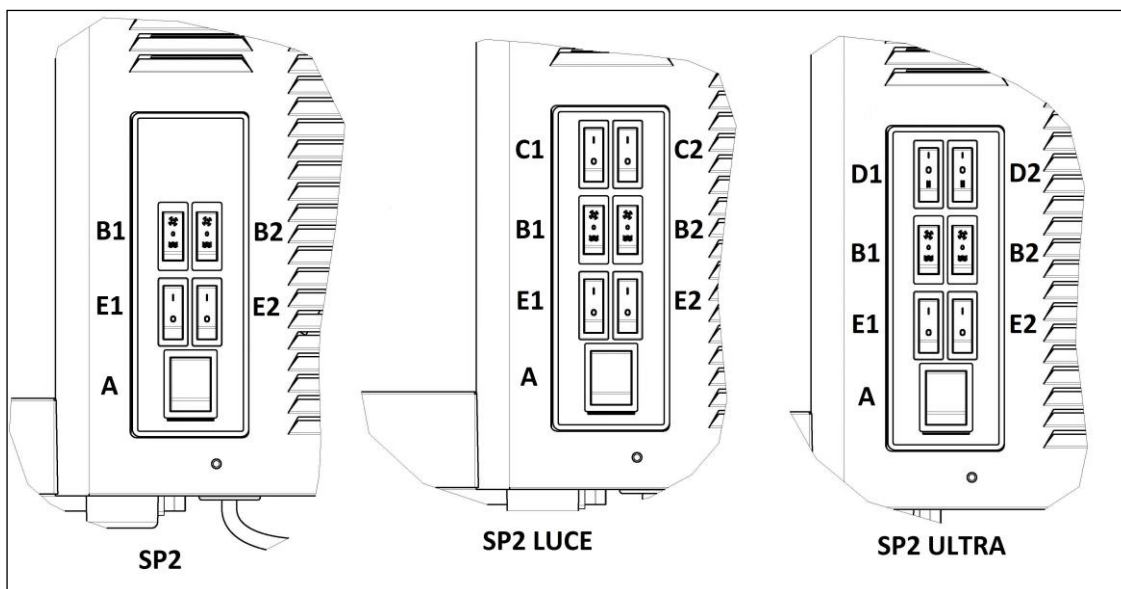

Fig. 21

**Note** -----  
**The SP ULTRA model machines are equipped with an effective nUVA LED lighting system that guarantees a 99% bactericidal effect in 4 hours.**  
 -----

## WARNING

**AVOID DIRECT AND CONTINUOUS (FOR MORE THAN 1 MINUTE) OBSERVATION AT SHORT DISTANCE (LESS THAN 60 CM) OF LIGHT SOURCES.**



## 9. THERMOSTAT CONTROLLER

The SP machine line is equipped with a digital display (fig. 22) that allows you to view the temperature in each tank.

### Operation mode



**The snowflake symbol at the top left of the display, lights up only when the refrigeration system is in operation.**

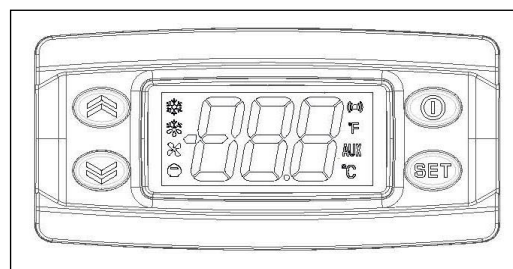

Fig. 22

### Freezing mode

Once the main switch A has been activated and the freezing mode (snowflake symbol) is selected on switch B, the machine will operate in HYBRID mode: the consistency of the product is INITIALLY defined mechanically by the adjustment of the spring through the wheel on the back of the machine (phase A).

Once the consistency level thus set has been reached, it is then maintained through the electronic temperature control which allows to always have the same consistency regardless of the quantity of product contained in the tank (phase B).

To identify the hybrid operation of the machine, during phase A, the image of a piggy bank at the bottom left flashes on the thermostat and stops flashing once the desired consistency is reached when the system switches to phase B.



If one of the following operations is performed:

- Turning the machine off and on
- Removing the lid for the refill
- Switch from freezing mode to defrost mode through switch B and then return to freezing mode

The hybrid system restarts from phase A.

### Night maintenance mode (defrost)

Once the main switch A has been activated and the night maintenance mode has been selected (drops symbol) on switch B, the machine will operate in night maintenance mode and the product temperature will be kept at + 1 ° C.



During this phase, the defrost symbol lights up on the display, half snowflake / half droplets, while the snowflake symbol lights up only when the refrigeration system is in operation.

### Washing mode

Once the main switch A has been activated and the washing mode has been selected (position 0) on switch B, the machine will work in washing mode and the refrigeration system will not be in operation.

**AUX** will appear on the right side of the display.



## 10.OPERATING INSTRUCTIONS AND START-UP PROCEDURES

### **!!IMPORTANT!**

**BEFORE STARTING THE MACHINE, CARRY OUT THE CLEANING AND SANITISING PROCEDURES DESCRIBED IN CHAPTER 9.**

- Dilute and mix the product in a separate container according to the manufacturer's instructions (see fig.23).

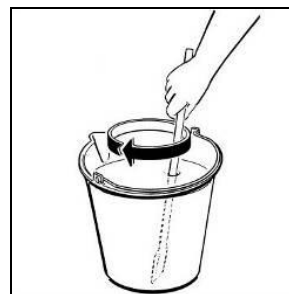

Fig. 23

**NOTE: "mix" is the result of the blending between water or milk with the powder to make slushes, sorbets, frozen creams ice milk, frozen yogurt and similar frozen dairy products.**

**ATTENTION: in order to avoid any damage to the appliance, it is recommended not to start the machine in freezing mode with less than 1.5 litres of product in the tank.**

- Pour the mix obtained into the bowl (see fig.24).

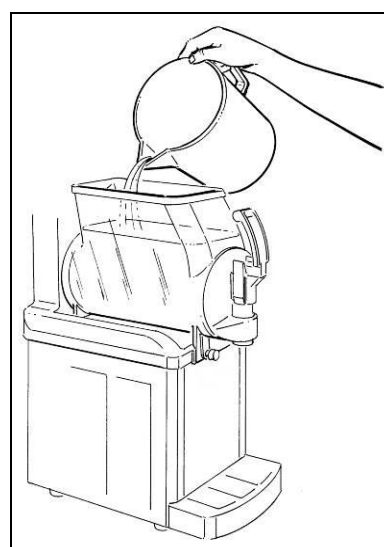

Fig. 24

- Restore the secondary cover and then the main one.

### **Note**

SP units are equipped with a very efficient safety mechanism designed to protect the operator; it is activated when cover is lifted. This device automatically and immediately stops all moving parts.

**If the main cover is not correctly positioned, the correspondent mixing system will not work.**

- Adjust the consistency to the desired level by turning the wheel located on the back of the machine (fig. 25); by turning clockwise to the left, the level indicator will move towards the - sign and the product will become less dense, by turning counter clockwise to the right, the level indicator will move towards the + sign and the product will become denser.

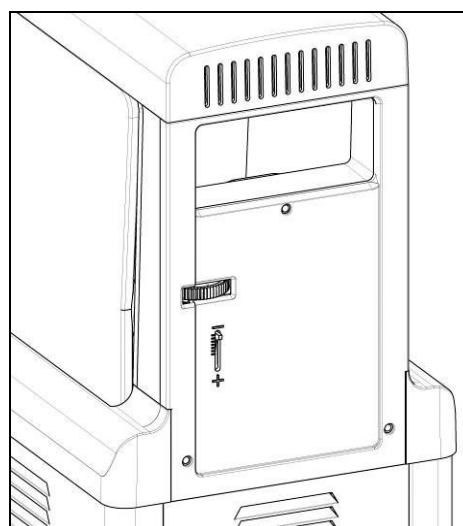

Fig. 25

- Insert the plug into the power socket.
- Activate the main switch A; the mixer will automatically start working in SP1 while in SP2 it will be necessary to activate the two mixers through the appropriate switches E1 and E2.

**⚠ Attention ⚠**

Not all products are equally sensitive to nUVA rays and therefore it is possible that some, subjected to prolonged irradiation over time, may undergo changes in colour.

In this case it is necessary to dose the irradiation considering that in 4 hours of exposure there is a bactericidal effect of 99%.

- Activate the freezing mode using switch B with the snowflake symbol (fig. 21).

**NOTE: in SP2 there are two buttons for freezing mode, B1 for the left tank and B2 for the right one.**

NOTE: if you wish to switch from FREEZING mode to NIGHT mode (DEFROST), simply set the position with the drop symbol on key B (Fig. 21)

- The product is ready when the piggy bank symbol, indicated by the arrow on the display image, stops flashing.



- If the product does not have the desired consistency, it is necessary to set switch B to position 0, adjust the consistency as desired (fig. 25) and restart the cycle from phase A by positioning switch B back to position SNOWFLAKE (chapter 9).

- Once the product has reached the desired consistency, to dispense, place the glass under the tap and pull the lever as shown in figure 26.

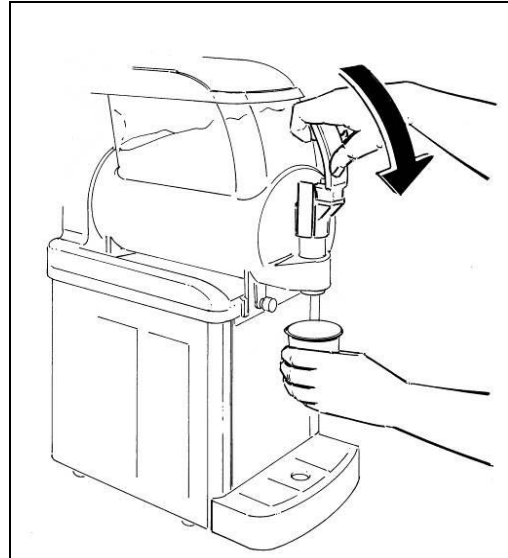
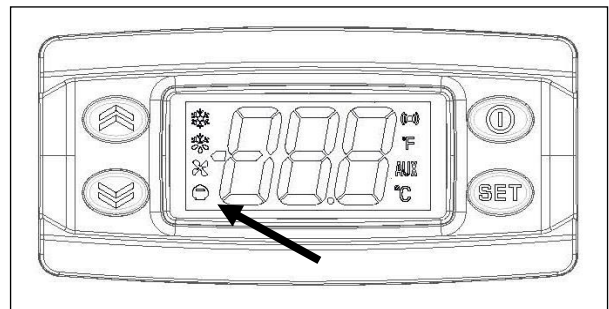

Fig. 26



## 11.SPECIAL MAINTENANCE



**Caution**

**Before proceeding with any maintenance operation, it is compulsory to switch off the machine and unplug it from the mains.**

### **Condenser cleaning**

In order to guarantee good cooling system performance, the condenser must be well cleaned **every month**.

How to reach it:

- Switch off the power supply and disconnect the power cable;
- Remove the rear panel by unscrewing the two bolts fastening it (fig.27);
- Using a dust exhauster, remove the dust that has collected between the condenser fins (fig.28).

#### **IMPORTANT**

**Never use a screwdriver or sharp object to clean between fins.**

#### **!CAUTION!**

**In order to reduce risks related to the refrigerant flammability, every special maintenance operation has to be performed ONLY by skilled service men.**

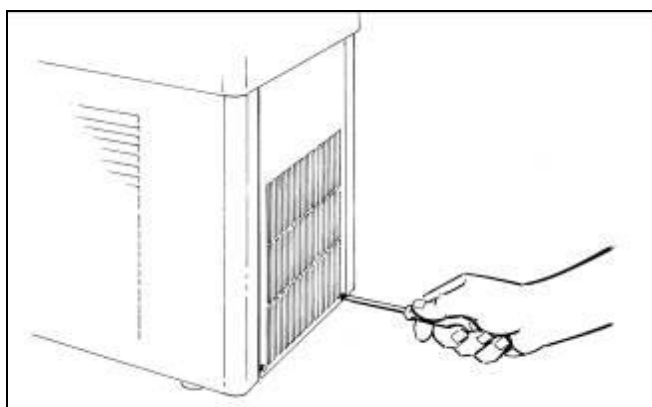

Fig. 27

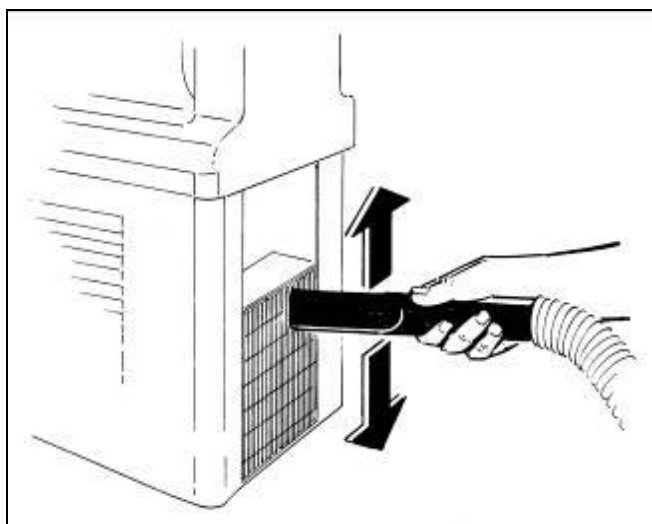

Fig. 28

## ***Control and replacement of seals***

### **EVAPORATOR HARD SEAL AND ITS SILICONE WASHER**

Replace every 9 to 12 months according to the conditions of use and level of maintenance.

### **BOWL GASKET (LOCATED AT THE REAR OF BOWL)**

Replace it every 12 months according to the conditions of use and level of maintenance.

### **DISPENSE VALVE O-RING**

The dispense valve o-rings should be replaced as necessary when wear is evident. Lubricate them each time they are replaced or the dispense valve is removed for cleaning.

### **SUCTION GASKET**

Replace every 3 months according to the conditions of use and level of maintenance. This part should be lubricated during the re-assembly after every cleaning with Vaseline.

## ***Winter storage***

To protect the unit during seasonal shutdown, it's important to properly store the machine using the following procedures:

- Disconnect all power to the freezer.
- Disassemble, wash and sanitize all parts that come into contact with the mix as described in chapter 1.
- Clean also all the exterior panels.
- Reassemble all these parts.
- Cover the machine with the original package to protect it from dust or other contaminating elements.
- Place the machine in dry location.

## ***Product storage***

Since the safety of the product used with this unit depends upon the temperature and the duration of storage, it is necessary to refer directly to the food product producer instruction and specifications in order to correctly manage it and in order to avoid any possible safety issue.

## **12. DISCLAIMER**

The manufacturer declines all responsibility for any damage that directly or indirectly might be brought on to people, things, animals, as a consequence of failure to comply with all instructions given in this manual with the warnings concerning installation procedures, use and maintenance of the machine.

The manufacturer cannot be held responsible for possible mistakes due to printing, copying or translating errors contained in this manual. In addition, the manufacturer reserves the right to modify what deemed necessary or useful for the machine, as well as for the benefit of the user, yet at the same time maintaining the essential operative and safety characteristics of said machine.

### 13.TROUBLESHOOTING GUIDE

**NOTE: the following procedures must be performed by a qualified service technician.**

<b>Problem</b>	<b>Possible cause</b>	<b>Solution</b>
The machine does not cool, or cools only partially and the compressor is running	<ul style="list-style-type: none"> <li>• The space around the machine is inadequate for ventilation</li> <li>• The refrigeration system is working in DEFROST mode</li> <li>• The condenser fins are clogged with airborne particles</li> <li>• Fan motor is not running</li> <li>• Refrigerant is leaking</li> <li>• The solenoid valve is faulty</li> <li>• The thermostat is faulty</li> </ul>	<ul style="list-style-type: none"> <li>• Allow at least 20cm between the machine and anything next to it; keep it away from heat sources</li> <li>• Return to FREEZE mode</li> <li>• Clean the condenser fins</li> <li>• Check the fan motor's electrical connections and, if disconnected, reconnect. If still not operating, replace the motor</li> <li>• Locate the leak, eliminate it and recharge the system</li> <li>• Replace the solenoid valve</li> <li>• Replace the thermostat</li> </ul>
The machine does not cool, or cools only partially and the compressor is not running	<ul style="list-style-type: none"> <li>• Electrical components of the compressor are not functioning</li> <li>• Some electrical connections are not complete</li> <li>• The compressor is malfunctioning</li> </ul>	<ul style="list-style-type: none"> <li>• Replace the malfunctioning components</li> <li>• Check the contacts and correct those incomplete</li> <li>• Replace the compressor</li> </ul>
The machine is noisy	<ul style="list-style-type: none"> <li>• The fan motor blades are hitting internal components</li> </ul>	<ul style="list-style-type: none"> <li>• Check and correct</li> </ul>
The main power switch is "ON" but the unit is not running	<ul style="list-style-type: none"> <li>• The main cover is not correctly assembled</li> <li>• Some electrical connections are not complete</li> <li>• The main power switch is broken</li> <li>• The thermostat is faulty</li> <li>• The gear motor is malfunctioning</li> </ul>	<ul style="list-style-type: none"> <li>• Assemble the main cover correctly</li> <li>• Check the contacts and correct those incomplete</li> <li>• Replace the switch</li> <li>• Replace the thermostat</li> <li>• Replace the gear motor</li> </ul>
The bowl is leaking	<ul style="list-style-type: none"> <li>• One of the bowl seal is not in place</li> </ul>	<ul style="list-style-type: none"> <li>• Replace or reposition the seal</li> </ul>
The dispensing valve is leaking	<ul style="list-style-type: none"> <li>• The dispensing valve has been incompletely or incorrectly replaced in its position</li> <li>• The free movement of the valve is impeded</li> <li>• Dispensing valve o-rings are damaged</li> </ul>	<ul style="list-style-type: none"> <li>• Reassemble and replace</li> <li>• Clean and lubricate the valve and the valve cylinder with the lubricant provided with the machine</li> <li>• Replace the o-rings</li> </ul>
Product is flowing into drain tray through drainage pipe	<ul style="list-style-type: none"> <li>• The bell shaped seal between the front of the cylinder and the auger hub has not been reinstalled properly</li> <li>• The bell shaped shaft seal or the spindle bushing seal is damaged or worn</li> </ul>	<ul style="list-style-type: none"> <li>• Find the seal and put it back in place</li> <li>• Replace the damaged/worn seal and check the condition of the drive shaft</li> </ul>
The auger is not turning	<ul style="list-style-type: none"> <li>• The main cover is not correctly assembled</li> <li>• Some electrical connections are not complete</li> <li>• The gear motor is malfunctioning</li> </ul>	<ul style="list-style-type: none"> <li>• Assemble the main cover correctly</li> <li>• Check the contacts and correct those incomplete</li> <li>• Replace the gear motor</li> </ul>
The auger is creating noise as it rotates	<ul style="list-style-type: none"> <li>• The bell shaped shaft seal has been replaced without lubrication or is damaged</li> <li>• The auger has been incompletely or incorrectly reassembled</li> </ul>	<ul style="list-style-type: none"> <li>• Replace or clean and lubricate with the lubricant provided with the machine</li> <li>• Check and correct</li> </ul>

# 14. WIRING DIAGRAM

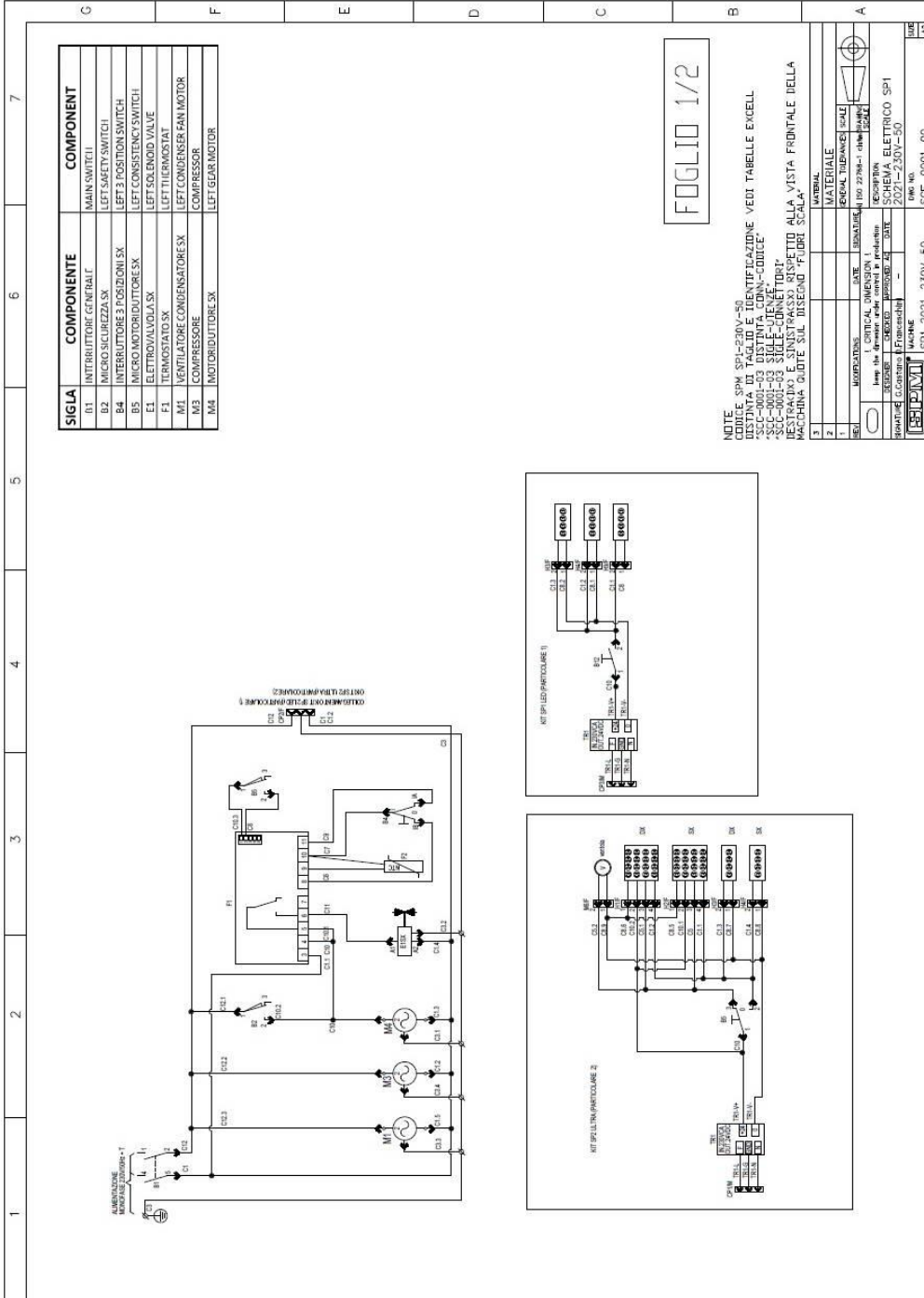

SIGLA	COMPONENTE	COMPONENT
B1	INTERRUTTORE GENERALE	MAIN SWITCH
B2	MICRO SICUREZZA SX	LEFT SAFETY SWITCH
B3	INTERRUTTORE 3 POSIZIONI SX	LEFT 3 POSITION SWITCH
B4	MICRO MOTORI OUTTORE SX	LEFT CONSISTENCY SWITCH
B5	MICRO MOTORI OUTTORE SX	LEFT CONSISTENCY SWITCH
E1	ELETTROVALVOLA SX	LEFT SOLENOID VALVE
F1	TERMOSTATO SX	LEFT THERMOSTAT
M1	VENTILATORE CONDENSATORE SX	LEFT CONDENSER FAN MOTOR
M2	COMPRESSORE	COMPRESSOR
M3	MOTORI OUTTORE SX	LEFT LGAR MOTOR
M4	MOTORI OUTTORE SX	LEFT LGAR MOTOR

FOGLIO 1/2

NOTE  
 CODICE SPM SP1-230V-50  
 DESTINATA DI TAGLIO E IDENTIFICAZIONE VEDI TABELLE EXCELL  
 PER INFORMAZIONI SULLE CARATTERISTICHE TECNICHE  
 VISITARE IL SITO WWW.SOLE-CONNECT.IT  
 SCHEMA ELETTRICO SP1  
 2021-230V-50

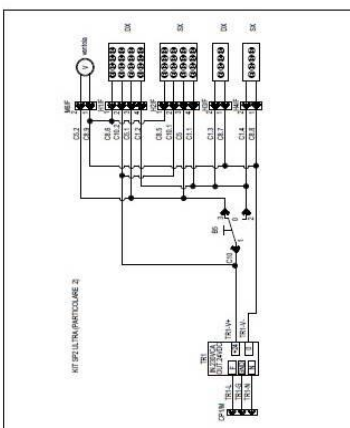
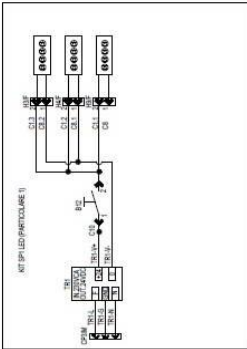

NO.	DESCRIZIONE	QUANTITA'	UNITA'	REVISIONE	DATA	REVISIONE	DATA
1	SCHEMA ELETTRICO SP1	1	FOGLIO	01	2021-01-01		
2	SCHEMA ELETTRICO SP1	1	FOGLIO	02	2021-01-01		

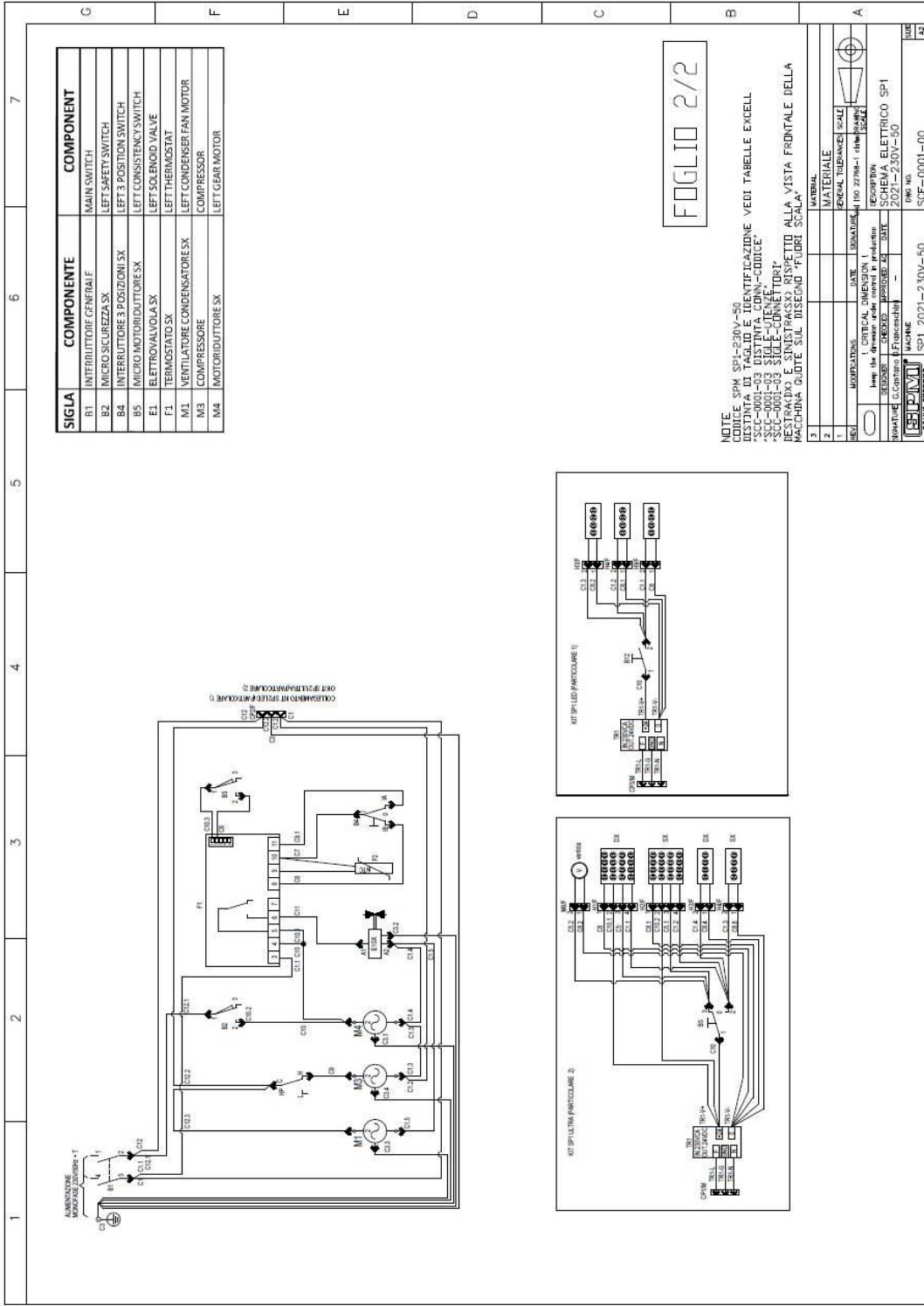

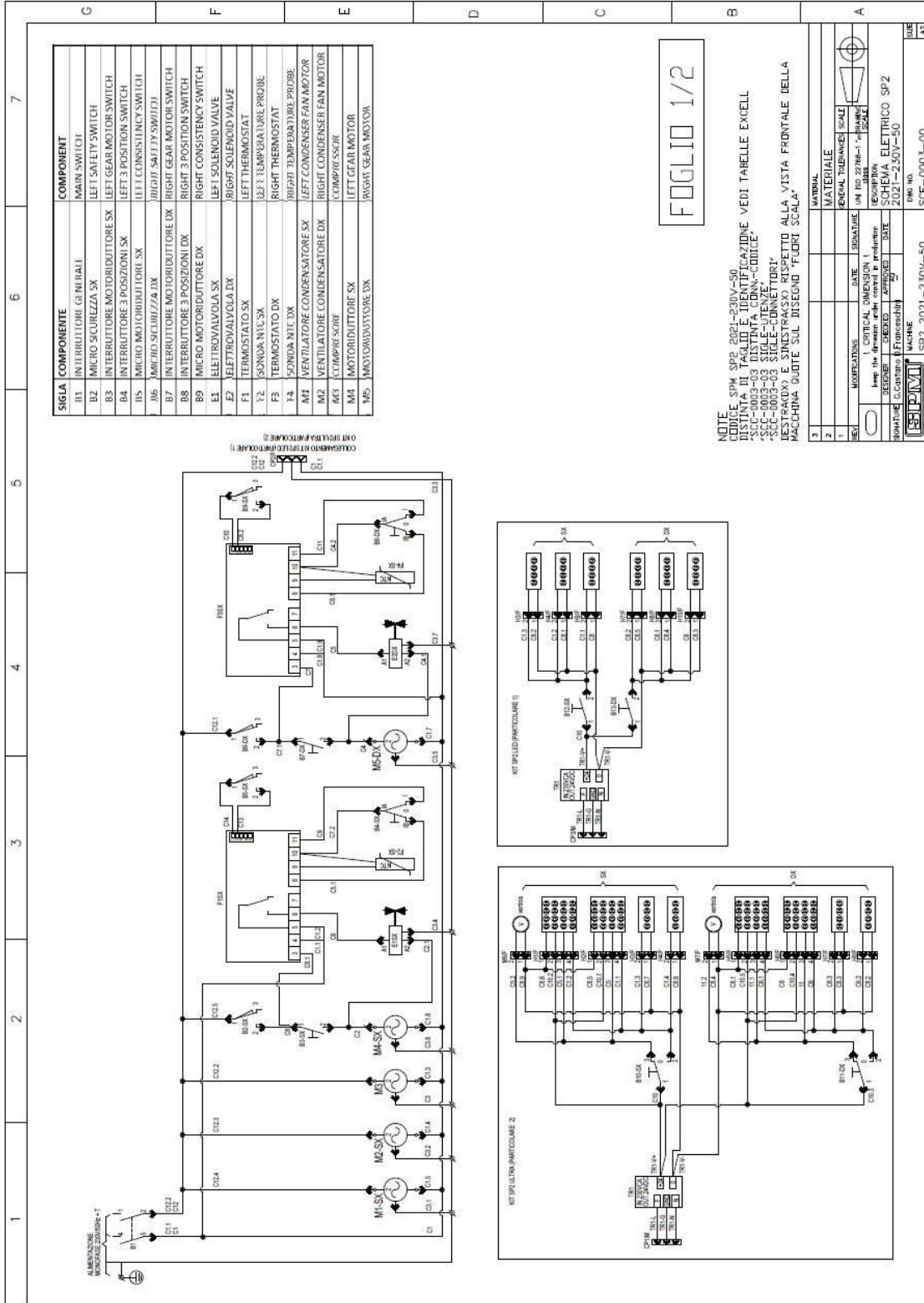

SIGLA	COMPONENTE	COMPONENT
B1	INTERRUTTORE GENERALE	MAIN SWITCH
B2	MICRO SICUREZZA SX	LEFT SAFETY SWITCH
B3	INTERRUTTORE MOTORIDUTTORE SX	LEFT GEAR MOTOR SWITCH
B4	INTERRUTTORE 3 POSIZIONI SX	LEFT 3 POSITION SWITCH
B5	MICRO MOTORIDUTTORE SX	LEFT CONSISTENCY SWITCH
B6	MICRO SICUREZZA DX	RIGHT SAFETY SWITCH
B7	INTERRUTTORE MOTORIDUTTORE DX	RIGHT GEAR MOTOR SWITCH
B8	INTERRUTTORE 3 POSIZIONI DX	RIGHT 3 POSITION SWITCH
B9	MICRO MOTORIDUTTORE DX	RIGHT CONSISTENCY SWITCH
E1	ELETTROVALVOLA SX	LEFT SOLENOID VALVE
E2	ELETTROVALVOLA DX	RIGHT SOLENOID VALVE
F1	TERMOSTATO SX	LEFT THERMOSTAT
F2	TERMOSTATO DX	RIGHT THERMOSTAT
F3	SONDINA MISC SX	LEFT TEMPERATURE PROBE
F4	SONDINA MISC DX	RIGHT TEMPERATURE PROBE
M1	VENTILATORE CONDENSATORE SX	LEFT CONDENSER FAN MOTOR
M2	VENTILATORE CONDENSATORE DX	RIGHT CONDENSER FAN MOTOR
M3	COMPRESSORE	COMPRESSOR
M4	MOTORIDUTTORE SX	LEFT GEAR MOTOR
M5	MOTORIDUTTORE DX	RIGHT GEAR MOTOR

FOGLIO 1/2

NOTE  
 CODICE SPM SP2 2021-230V-50  
 DISTINTA DI TAVOLO E IDENTIFICAZIONE VEDI TABELLE EXCELL  
 -SCC-003-03 DISTINTA CON-CODICE  
 -SCC-003-03 SILE-CONNETTORI  
 DESTRA(DX) E SINISTRA(SX) RISPETTO ALLA VISTA FRONTALE BELLA  
 MACCHINA QUOTE SUL INSEGNO "FLORI SCALA"

MATERIALE	
1	DESCRIPTION
2	QUANTITY
3	UNIT



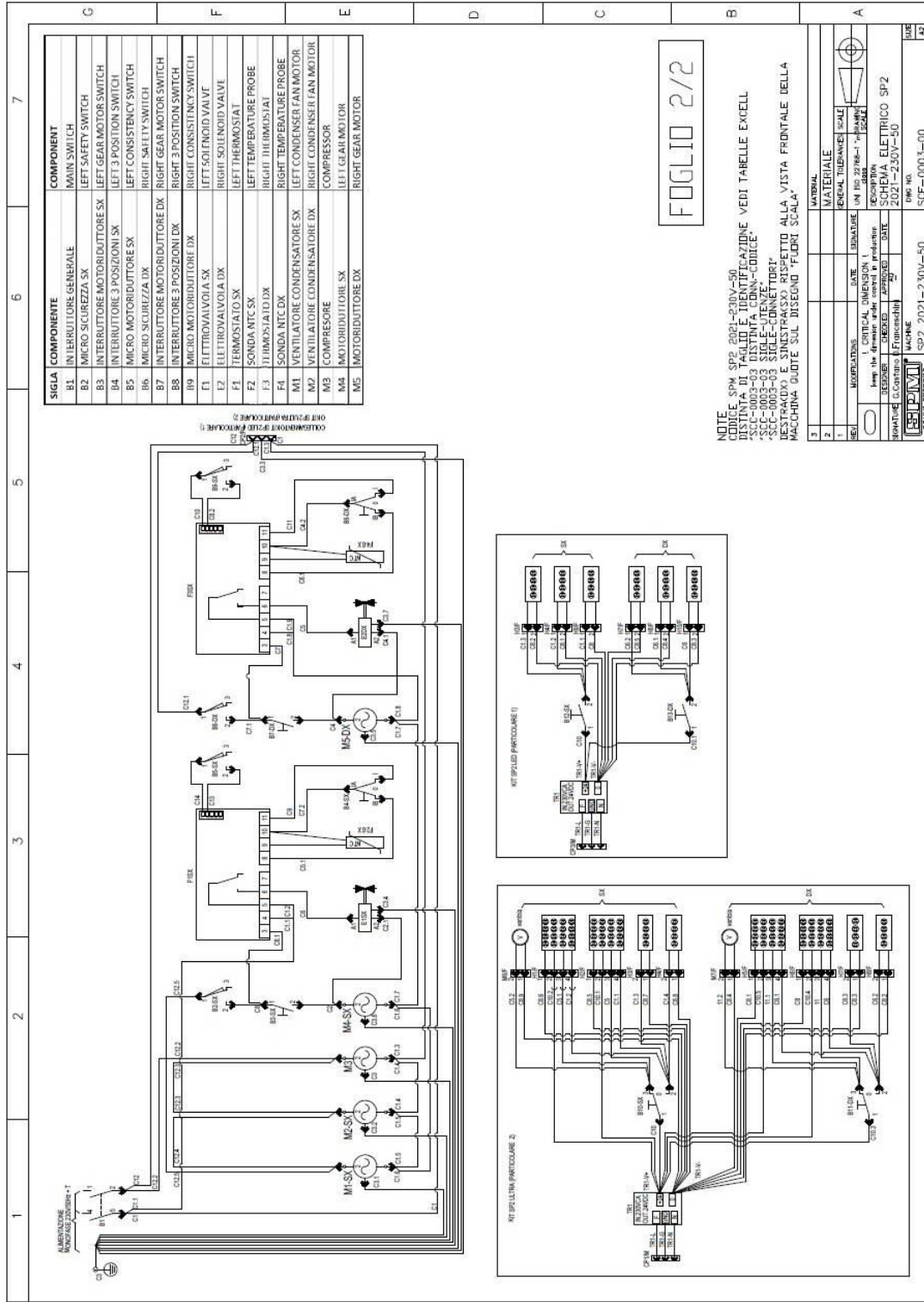

SIGLA	COMPONENTE	COMPONENT
B1	INTERRUTTORE GENERALE	MAIN SWITCH
B2	MICRO SICUREZZA SX	LEFT SAFETY SWITCH
B3	INTERRUTTORE MOTORIDUTTORE SX	LEFT GEAR MOTOR SWITCH
B4	INTERRUTTORE 3 POSIZIONI SX	LEFT 3 POSITION SWITCH
B5	MICRO MOTORIDUTTORE SX	LEFT CONSISTENCY SWITCH
B6	MICRO SICUREZZA DX	RIGHT SAFETY SWITCH
B7	INTERRUTTORE MOTORIDUTTORE DX	RIGHT GEAR MOTOR SWITCH
B8	INTERRUTTORE 3 POSIZIONI DX	RIGHT 3 POSITION SWITCH
B9	MICRO MOTORIDUTTORE DX	RIGHT CONSISTENCY SWITCH
F1	ELETTRIVALVOIA SX	LEFT SOLENOID VALVE
F2	ELETTRIVALVOIA DX	RIGHT SOLENOID VALVE
F3	TERMOSTATO SX	LEFT THERMOSTAT
F4	TERMOSTATO DX	RIGHT THERMOSTAT
F5	SONDA NTC SX	LEFT TEMPERATURE PROBE
F6	SONDA NTC DX	RIGHT TEMPERATURE PROBE
M1	VENTILATORE CONDENSATORE SX	LEFT CONDENSER FAN MOTOR
M2	VENTILATORE CONDENSATORE DX	RIGHT CONDENSER FAN MOTOR
M3	COMPRESSORE	COMPRESSOR
M4	MOTORIDUTTORE SX	LEFT GEAR MOTOR
M5	MOTORIDUTTORE DX	RIGHT GEAR MOTOR

FOGLIO 2/2

NOTE SPM SP2 2021-230V-50  
 DISTINTA DI TAGLIO E IDENTIFICAZIONE VEDI TABELLE EXCELL  
 \*SCE-0003-03 DISTINTA CONN-CODICE\*  
 \*SCE-0003-03 SILE-KENNER\*  
 \*SCE-0003-03 SILE-KENNER\*  
 DESTRA(DX) E SINISTRA(SX) RISPETTO ALLA VISTA FRONTALE DELLA  
 MACCHINA QUOTE SUL DISEGNO "FLORI SCALA"

3	REVISIONI	DATE	REVISIONE	SCALE
1	1			
2	2			

MATERIALI	MATERIALE
ENGLISH	ENGLISH
DESCRIPTION	DESCRIPTION
DATE	DATE
SCALE	SCALE

SP2 2021-230V-50	SCE-0003-00
SP2 2021-230V-50	SCE-0003-00



# **ASSISTENZA TECNICA ITALIA**

Mail:

[infoservicek@electroluxprofessional.com](mailto:infoservicek@electroluxprofessional.com)

Tel. +39 059 782884

# **INTERNATIONAL CUSTOMER CARE**

Mail:

[SPM.aftersales@electroluxprofessional.com](mailto:SPM.aftersales@electroluxprofessional.com)

Phone: +39 059 781761

# **US CUSTOMER CARE**

**Grindmaster-Cecilware**

4003 Collins Lane, Louisville, KY 40245 USA

Phone: 502.425.4776 Toll Free: 800.695.4500

Fax: 502.425.4664

Web: [www.grindmaster.com/service](http://www.grindmaster.com/service)

# **ELECTROLUX PROFESSIONAL**

Mail:

[epr.techhelp@electroluxprofessional.com](mailto:epr.techhelp@electroluxprofessional.com)

CE

S.P.M. Drink Systems S.p.A.  
Via Panaro 2/b  
41057 Spilamberto (MO)